

Panel Specification & Accessories



**SAUDI
MADE**



www.bcoms.com

Material Specification For Sandwich & Single Skin Panels

BCOMS supply Sandwich panels & Single Skin for Roof & Wall sheeting in two different base metals i.e Steel and Aluminum.

Steel Panels

Steel Panels are available in nominal skin thickness of 0.5mm & 0.7mm in Zinalume & Galvanized primer coating.

Zinalume steel panels confirm to ASTM A 792M. This panels are coated with corrosion resistant Zinc-Aluminum alloy metallic coating through a continuous hot-dip process.

Galvanized steel panels confirms to ASTM A653M with metallic coating through a continuous hot-dip process.

Steel base metal is used for single skin panels and for outer & inner skin of sandwich panels.

Aluminum Panels

Aluminum panel confirms to ASTM B 209M ALLOY 3003/3105(H26) and is available in nominal thickness of 0.5mm & 0.7mm.

Finish Coating of panels

BCOMS standard pre-painted panel is a Modified polyester polymer coated over Zinalume or Galvanized steel & Aluminum substrate. Nominal thickness of finish coating is 25 microns of high durability modified polyester polymer applied on the exterior (weather) face and 5-7 microns of plain polyester applied on the interior face.

Panels with modified polyester polymer finish are stocked in all BCOMS standard colors.

BCOMS also offers high performance Polyvinylidene Fluoride well-known as PVF2 (equivalent to Kynar 500) coating applied over Zinalume or Galvanized steel. It is a Pre-Painted panel with nominal finish thickness 25 microns of Polyvinylidene Fluoride on the exterior (weather) face and 5-7 microns of plain polyester on the interior face.

This paint system provides more protection to the panel in terms of longer life and long-term color and gloss finish durability.

Panel Profiles

Single Skin Roof and Wall panels

"Type-S1" single skin profile in steel and aluminum is BCOMS standard roof panel. It is also used as wall panel. "Type-S1" is a superior structural panel whose profile is designed to withstand heavy loads, such as roof snow load and uplift loads resulting from high velocity (cyclonic) winds.

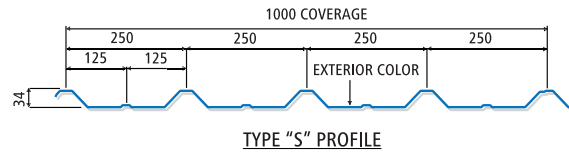

Polyisocyanurate (PIR) Sandwich Panels

BCOMS sandwich panel is a composite panel consisting of two skins and the fire retardant polyisocyanurate (PIR) foam core with density of 38 - 40KG/m³. Polyisocyanurate (PIR) foam core has a thermal conductivity of $K=0.022W/m^2K$

The exposed outer skin is roll formed from steel or aluminum coils and the inner skin is made up of the same material as outer skin in addition to "Fiber Reinforced Liner" (FRL) option.

PIR Sandwich panels are available in two different types:

- 1) Tempcon sandwich panels (TCSQ) that are produced using rigid Polyisocyanurate (PIR) foam core with external and internal sheet in steel or aluminum and profile of outer skin is Type-S1 & profile of inner skin is Type-Q. TCSQ panels are suitable for roof and wall of all building applications.

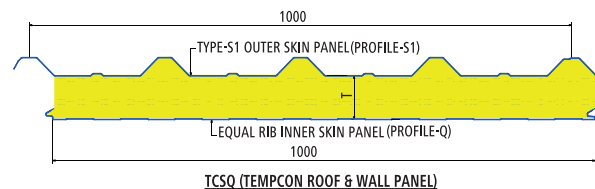

- 2) Temparch Sandwich panels (TA) are aesthetic wall panels also produced using rigid Polyisocyanurate (PIR) foam core with external and internal sheet in steel or aluminum. Temparch sandwich panels have a unique detail to conceal fasteners and are therefore more suitable for walls & interior partition in showrooms, hypermarkets, shopping malls and commercial buildings.

Moreover, panels can be specially ordered based on cus-

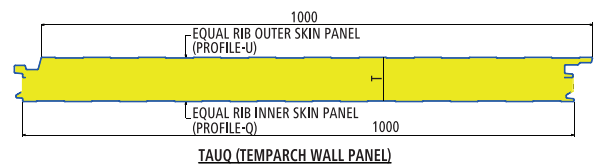

tomer specifications & requirements to meet a wide range of base metal specifications, coating finish, color and thickness.

Consult our sales dept. for complete information on price and delivery period.

Flashing ,Trims & Accessories for Roof & Walls:

Flashing & Trims are sheet metal closures designed primarily to provide weather tightness and neat appearance at corners and junctions of the buildings.

We supply appropriate flashing & trims as per the building requirements. Flashing, trims and other accessories are produced using same materials as used for roof & wall sheeting.

We also supply Eave gutters, downspouts, curved eaves, ridge

panels and other related accessories which contribute to the function, tightness & completeness of the building and enhance the overall appearance of the building.

BCOMS standard flashings, trims and accessories at Roof & Walls are shown in the below drawings.

Moreover BCOMS can supply any type of flashing/trims to suit any desired requirement of the customer.

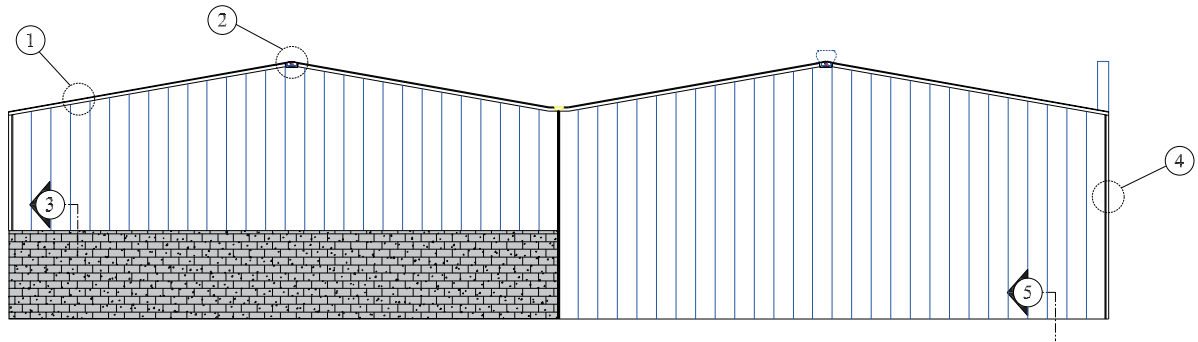

ENDWALL ELEVATION

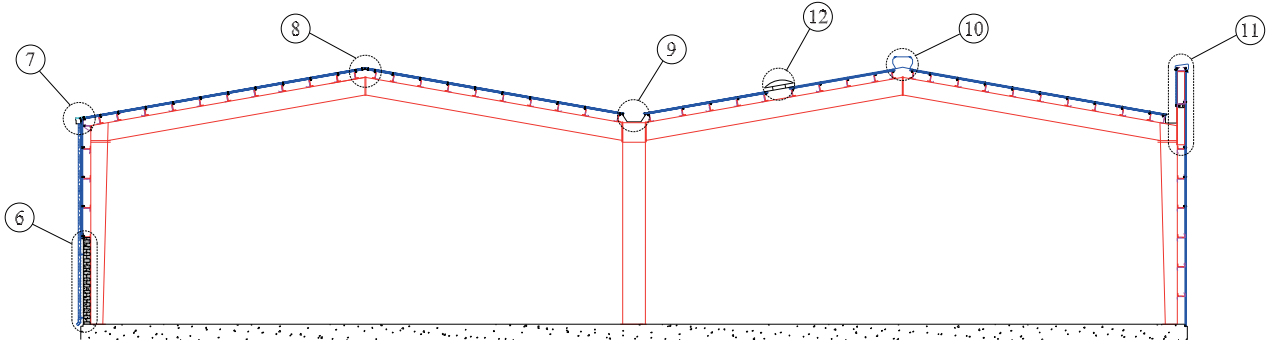

CROSS-SECTION

TYPICAL FLASHING AND TRIMS AND ACCESSORIES AT ROOF AND WALLS

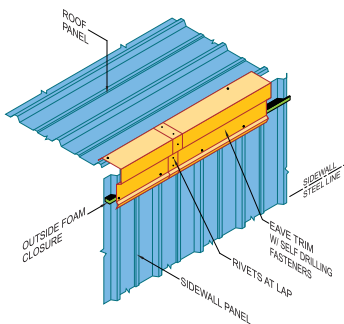

Detail-1: Eave Trim

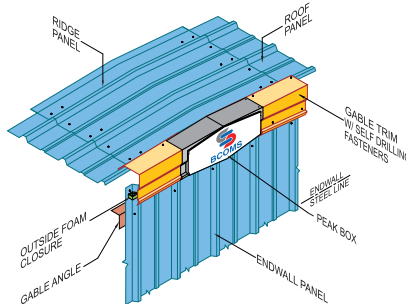

Detail-2: Gable Trim

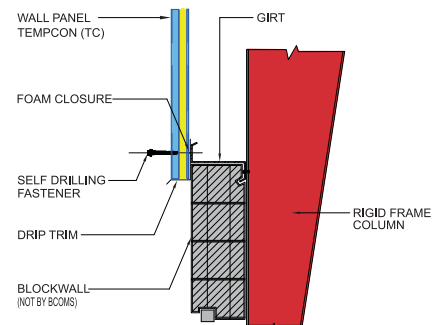

Detail-3: Drip Trim

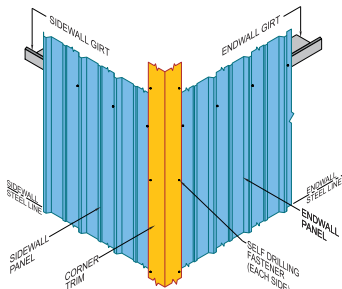

Detail-4: Corner Trim

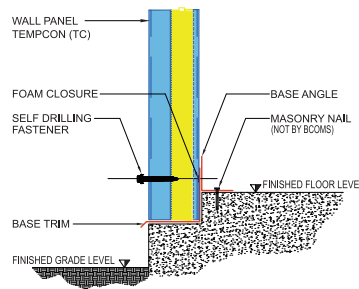

Detail-5: Base Trim

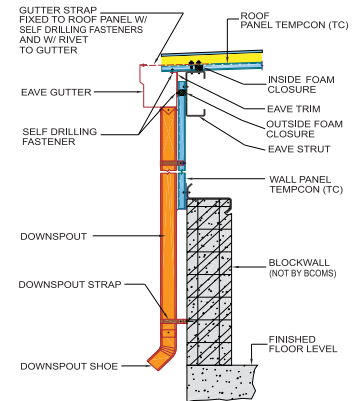

Detail-6: Downspout

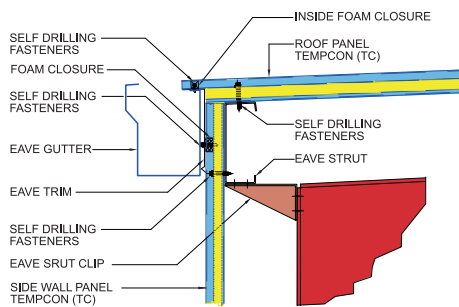

Detail-7: Eave Gutter

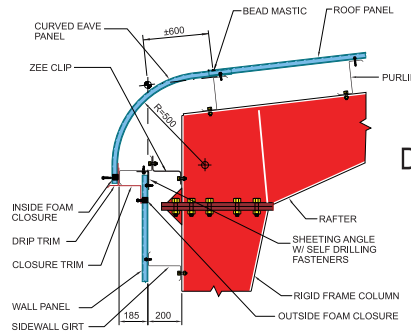

Detail-7: Curved Eave (Optional)

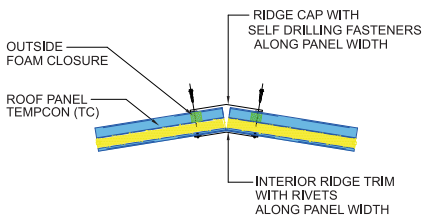

Detail-8: Ridg Cap & Ridge Trim

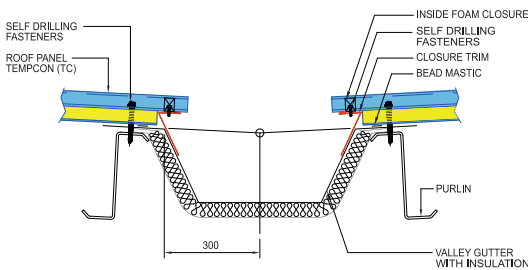

Detail-9: Valley Gutter

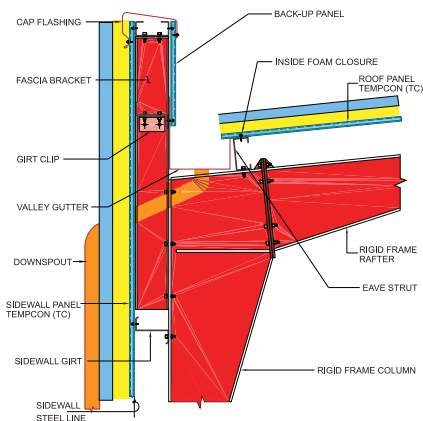

Detail-11: Parapet Fascia

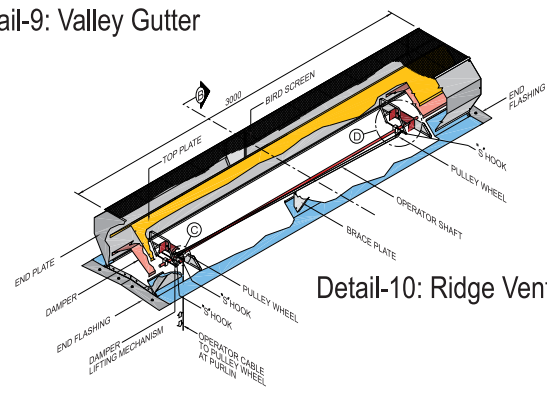

Detail-10: Ridge Ventilator

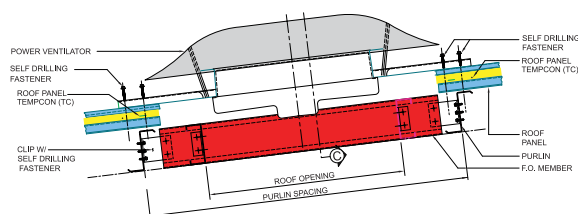

Detail-12: Power Ventilator

Sundry Items:

Below mentioned sundry Items forms a basic part of our scope of supply & are supplied along with sheeting materials.

Fasteners: Standard Carbon steel screws with washers as per the requirement are supplied along with sheeting.

Pop Rivets: Standard pop rivets for joining light gauge trims

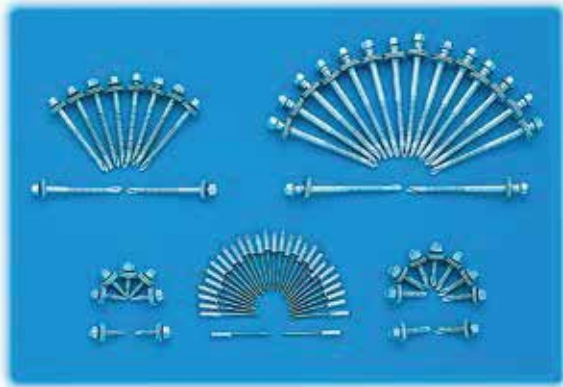

and flashings.

Foam Closure: Foam closures are standard supplied sundry parts for weather tight sealing between panels and trims at the eave, gable, base, canopy, ridge as well as above blockwall areas. The type of foam closure supplied depends on the panel profile supplied.

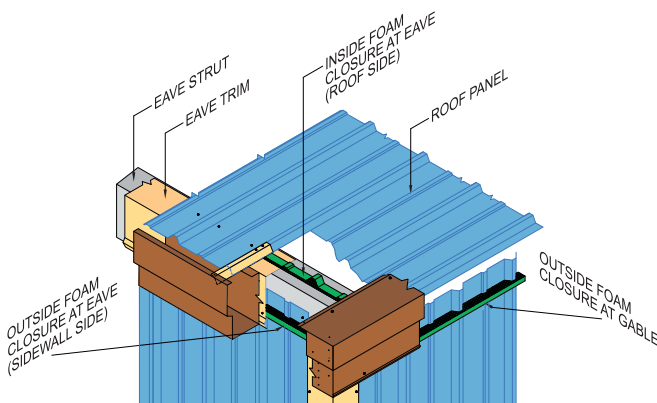

Foam closure are made of rigid polyethylene foam that has very high resistance to ultraviolet rays, can withstand harsh environments and resists some aggressive chemical attacks.

Bead Mastic: It is a high performance tacky elastic butyl tape with silicone release paper designed to bond panels and valley gutter. It is engineered to withstand extreme roof temperature while offering low temperature compressibility and resistance to cold flow.

Flowable Mastic: It is a high performance solvent release pigmented acrylic compound sealant ideal for sealing critical laps in gutters, downspouts etc. It remains ductile in the presence of ultraviolet and infrared radiation, making it an excellent general purpose sealant.

We maintain a steady & up-to-date stock of all these items to ensure immediate delivery.

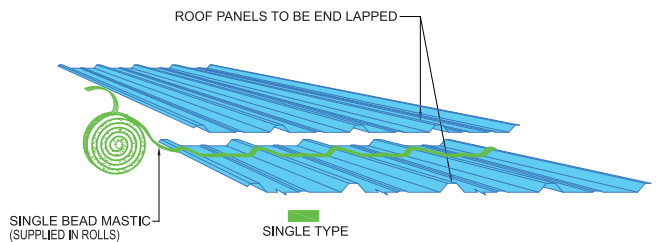

Panel Colors

BCOMS sandwich panels standard color is Frost White.

Moreover BCOMS can supply panels in any RAL color as per requirement of the customer. Consult our sales dept. for complete information on price and delivery period.

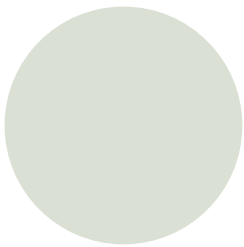

Frost White

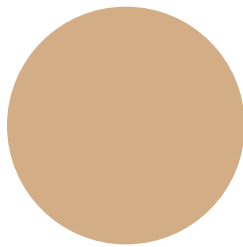

Arabian Beige

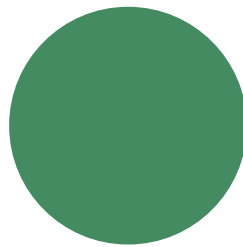

Leaf Green

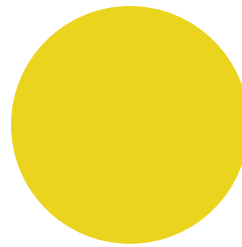

Daisy Yellow

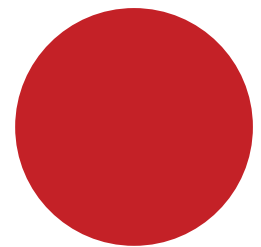

Flame Red

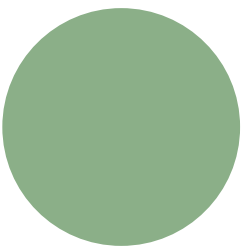

Cactus Green

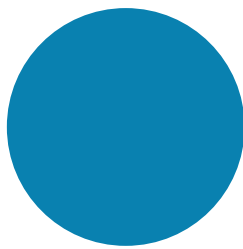

Royal Blue

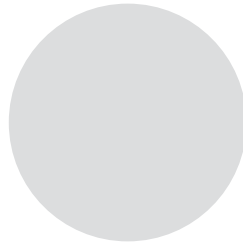

Silver Metallic

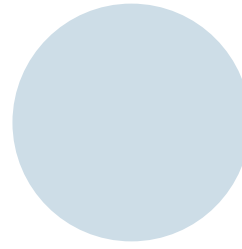

Grey Blue Metallic

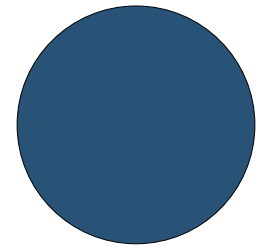

Shasta Blue



شركة مكونات البناء ذ.م.م.
BUILDING COMPONENT SOLUTIONS (LLC)
A subsidiary of **Zamil Industrial**



P.O. Box 14441, 2nd industrial Estate
Dammam 31424, KSA
Phone: (966 13) 812 4571 /72/73
Fax: (966 13) 812 4579

Dammam Sales Office:

Phone: (966 13) 812 4571 /72/73
Fax: (966 13) 812 4579

Riyadh Sales Office:

Phone: (966 11) 472 5555/5250
Fax: (966 11) 472 8019

Jeddah Sales Office:

Phone: (966 12) 660 0012
Fax: (966 12) 660 9707

e-mail: marketing@bcoms.com
www.bcoms.com

